

Full C.C.W Position

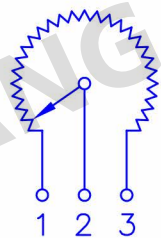

CIRCUIT

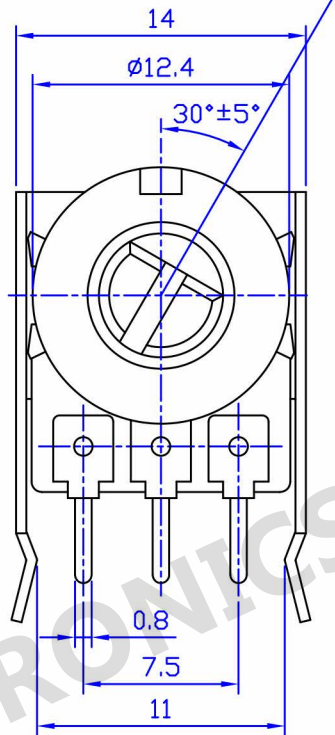
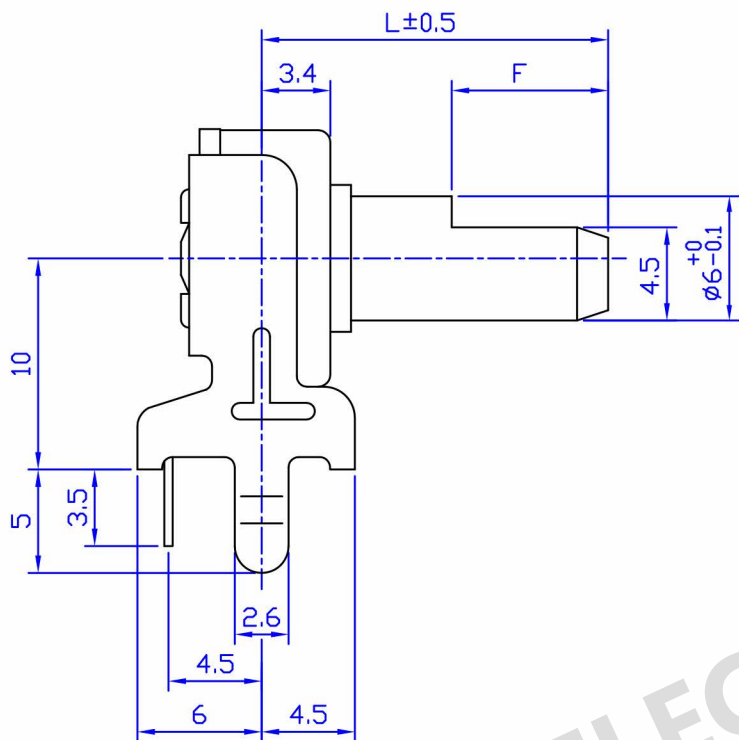
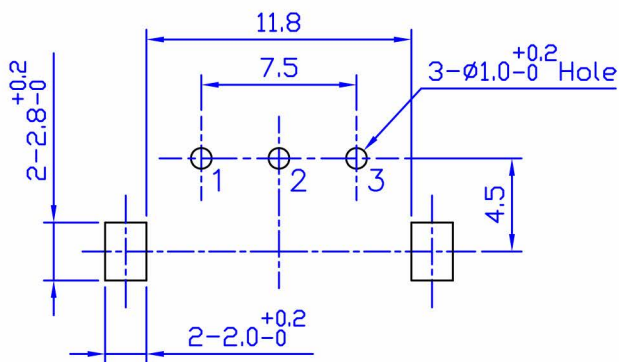

?????±?????	
10??	±0.3
10~100	±0.5
100??	±0.8
? ?	±5°

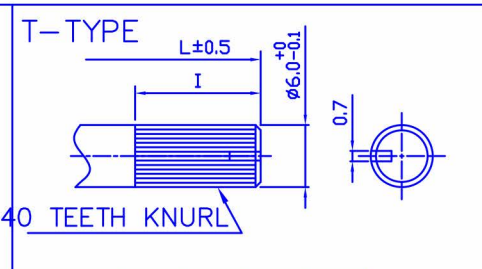
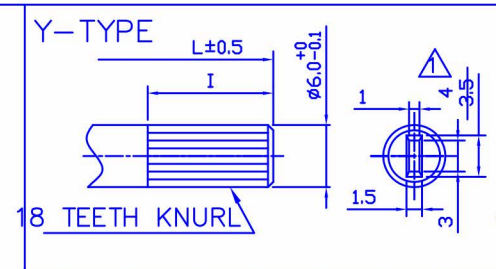
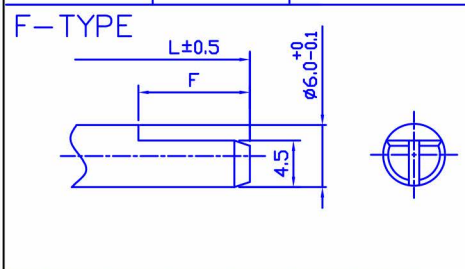

L	10	12	15	20	25	30
F	5	7	7	8	7	12

L	10	13	15	17	20	25	30
I	5	7	7	8	9	7	12

L	10	15	20	25	30
I	5	7	7	12	12

MTL			SPEC			DISPOSAL			惠州市弘旺电子有限公司					
△			UNIT	SCALE	TITLE	DB-122K Series								
△			MM	3 / 1										
△			DRAWN	DESIGN	CHECK	APPROVAL	DWG NAME DB-122K							
△			??	廖金華			DWG NO. DB-122K-08-001							
△	2003/07/04	???	DEVISION	DATE	DESIGN	1999.07.01								