

DRAWING FOR CUSTOMER

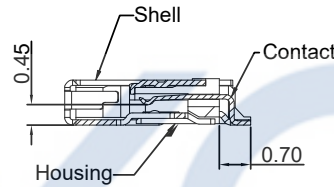

Section:A-A
Scale:2/1

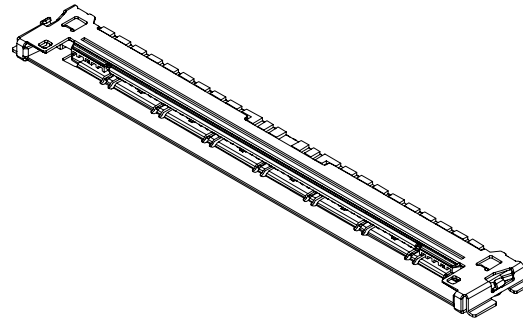
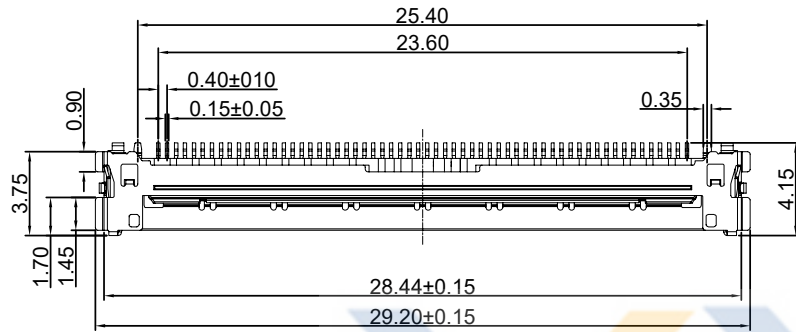
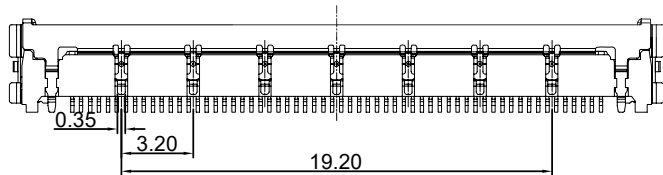
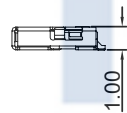
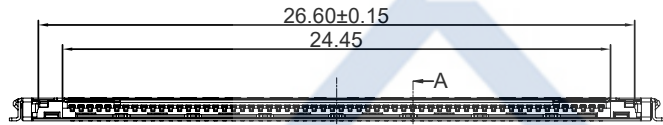

- SPEC.:
- Rated Voltage:100V AC,DC
 - Rated Current:0.8A AC,DC
 - Withstand Voltage:200V AC/minute
 - Contact Resistance:50mΩ max
 - Insulation Resistance:1000MΩ min
 - Temperature Range:-25℃~+85℃

- Material:
- Insulator:LCP UL94V-0,Black
 - Contact Pin:Copper alloy
Finish:Gold-plated,over Nickel
 - Shell:Copper alloy
Finish:Gold-plated,over Nickel

KB403-60 X S R 3 A

Pin No. Version
 Mold No.

包装方式:
T:TUBE (管装)
R:REEL (卷装)
P: PE (袋装)

S:SMT
D:DIP

R:Right Angle
V:Vertical

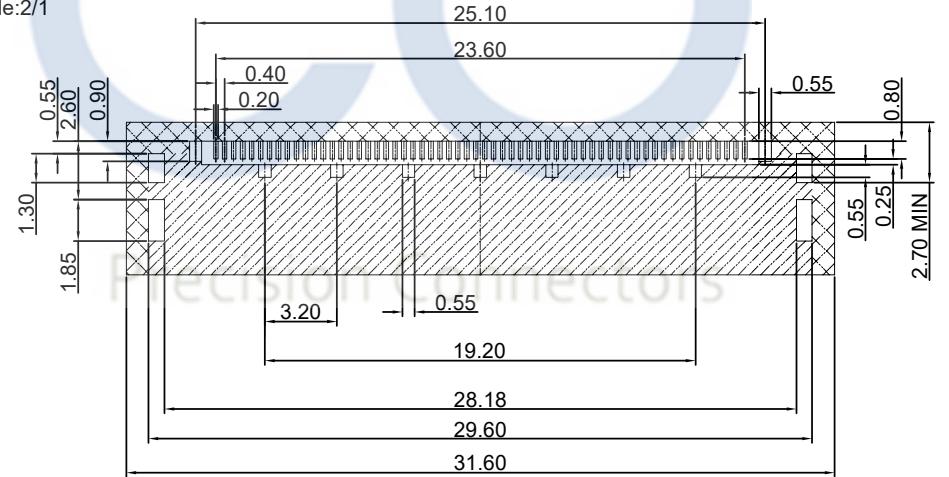

RECOMMENDED P.C. BOARD LAYOUT

XYCO 东莞市轩业电子科技有限公司
TEL: 0769-8297 9981/2/3 <http://www.XYCO.com.cn>

				TOLERANCE 公差		DRAWING 設計者		Devin		KB403-60XSR3A						
2017-04-25		A		.X=±0.30 .XX=±0.20 .XXX=±0.10		CHECKED 審查		Thomas		PART NO. 料號		UNIT 單位		mm		
DATE 日期	VER 版本	CHANGE HISTORY 變更歷史	CHANGED NAME 修改後料號	DRAWING 變更者	APPROVED 核准		William		DWG NO. 圖號		PE0911A		PRODUCT NAME 產品名稱		20525 PH0.5mm 60P Wire To Board SMT Right Angle Wafer	